

Determining Resistors in a Network with Boundary Conditions in One Step

Nathan Bramall

September 6, 1994

Abstract

This paper discusses the technique of probing a network of resistors with boundary currents and voltages in order to determine the resistance of any resistor in the network in one step.

Key Terms:

Network of Resistors: A *Network of Resistors* is a collection of *resistors* (also called *edges*) bound together at *nodes*, which obey *Ohm's Law* ($V=IR$). There are two types of *nodes*: *boundary nodes* and *interior nodes*. *Interior nodes* are *nodes* which must also obey *Kirchhoff's Current Law*, while *boundary nodes* do not. A *network of resistors* will also be referred to as a *network*.

Circular Planar Network of Resistors: A *Circular Planar Network* or resistors (or just *circular network*) is a network of resistors which can be embedded inside a topological disk D such that all the boundary nodes of the network lie on the boundary of D . See *Figure 1*.

Layer or Depth of a Node: The *layer of a node* is the minimum number of resistors that would need to be passed through to reach that node, starting from the boundary. The *layer or depth* of a node is determined inductively as follows:

- 1) Define the *depth* of all boundary nodes as zero.
- 2) Any node connected to a level zero node by a single edge, which has not already been defined as a level zero node, will be defined as a level one node.
- 3) Any node connected to a level one node by a single edge, which has not already been defined as a level one node, will be defined as a level two node.

Continue in this manner until all nodes in the network of resistors have been so labeled. The deeper the node, the greater its assigned value. *Example:* *Figure 1* has three boundary nodes and one level one node.

Layer or Depth of a Network: The *layer or depth of a network* will be defined as the depth of the deepest node in that network. *Example:* *Figure 1* is a level one network.

Layer or Depth of an Edge, Resistor, or Conductor will be defined as $i-j$, where i is the depth of one of the resistor's nodes on the and j is the depth of the other and $i \leq j$. *Example:* an edge formed between a layer 2 node and a layer 3 node is referred as a layer 2-3 edge. The deeper the edge, the larger the value of $(i+j)$. (Note: $0 \leq (j-i) \leq 1$)

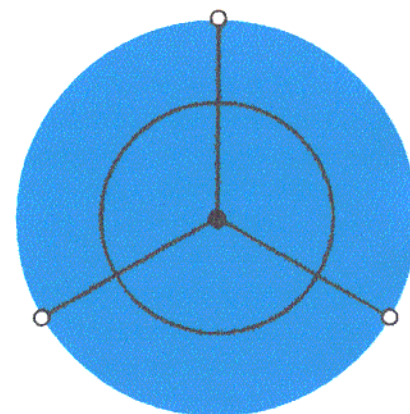

Figure 1: An example of a circular planar network. The white nodes are boundary nodes.

The Dirichlet-to-Neumann Map

Boundary voltages (called Dirichlet data) uniquely determine boundary currents (called Neumann data). The exact relationship is linear, being based on *Ohm's Law*, and is given by the following equation:

$$\Lambda \boldsymbol{\varphi} = \boldsymbol{\theta}$$

where $\Lambda = (\lambda_{ij})$ is the *Dirichlet-to-Neumann Map* represented by an $n \times n$ matrix (where n is the number of boundary nodes), $\boldsymbol{\varphi}$ is the $n \times 1$ column vector whose i^{th} entry corresponds to the voltage at the i^{th} boundary node and $\boldsymbol{\theta}$ is the $n \times 1$ column vector whose i^{th} entry corresponds to the resulting current at the i^{th} boundary node. For the purposes of this paper, we restrict ourselves to inspecting or specifying only Dirichlet and Neumann data.

Medial Graphs

Given a circular planar network of resistors, a *medial graph* is constructed by first placing vertices at the midpoint of each edge in the network and then joining all adjacent midpoints together (adjacent midpoints meaning that they lie on edges in the network which share a common node, but which can be joined together without crossing through another edge in the network). See **Figure 4a,b,c**. By doing this, you effectively enclose each interior node in its own cell. The treatment of boundary nodes is only slightly different. If the boundary node is on a spike (see **Figures 4c, 2a**) then the two medial line segments that cross through the spike surround that boundary node. If the boundary node is not on a spike, then medial lines from each side of the node will surround it (see **Figures 4c, 2b**). Notice that this also encloses the boundary nodes in cells.

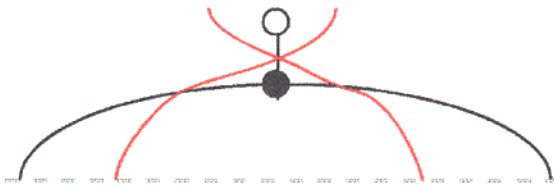

Figure 2a: Boundary node on a spike

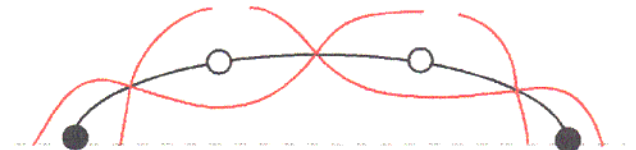

Figure 2b: Boundary nodes on an edge

Figure 2: White nodes are boundary nodes. Medial lines are shaded red. The network and interior nodes are black.

Medial Lines

The next step is to define medial lines in the medial graph. Each medial line begins and terminates at a point on the boundary (unless it is a closed loop--see below). Start at one of the terminating points and follow it through the network. At every intersection, choose the path such that it will bisect the other path (i.e. go 'straight' through each intersection) until you reach the boundary or otherwise come to an end, thus defining one medial line. See **Figures 4d, 3**. Continue in this manner until all the edges in the medial graph are contained in medial lines.

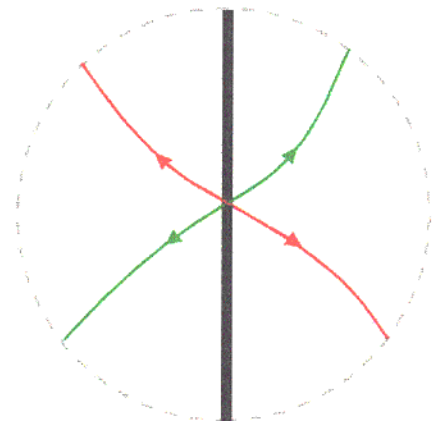

Figure 3: Crossing medial lines

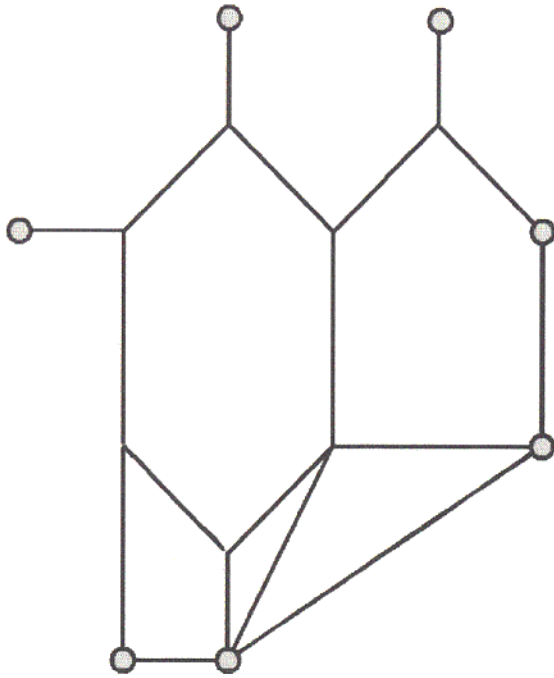

Figure 4a: Given a circular planar graph.

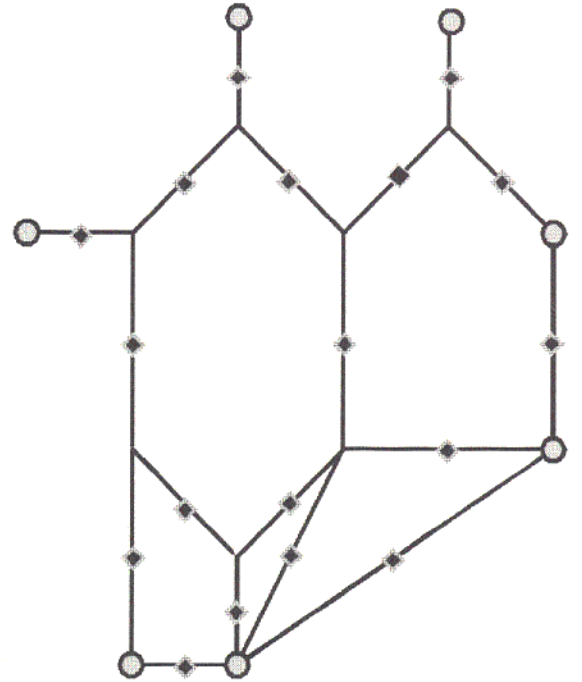

Figure 4b: Mark the midpoints of each edge in the network.

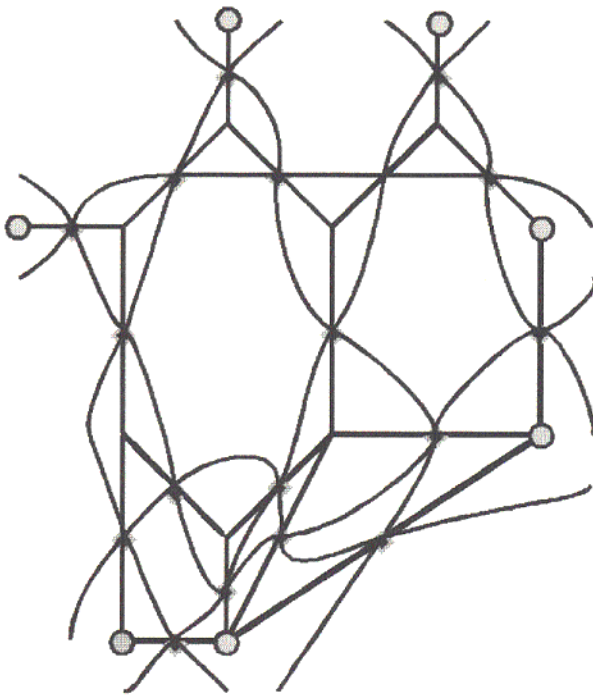

Figure 4c: Connect adjacent edges

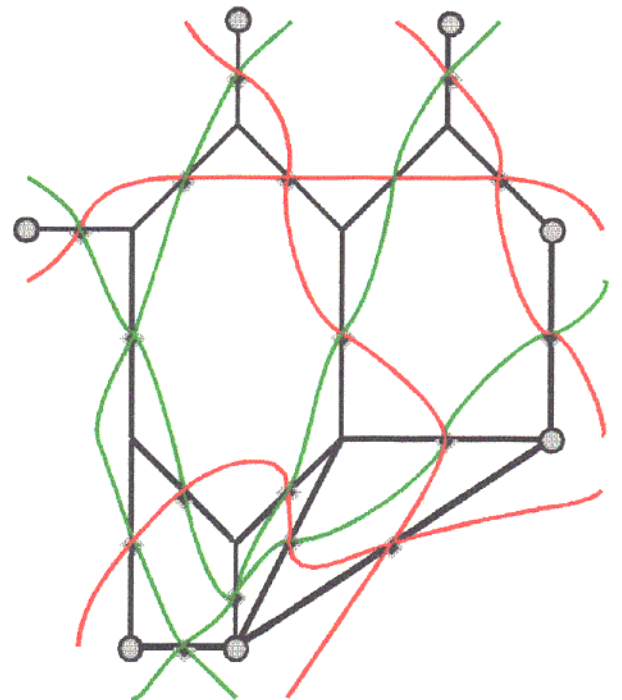

Figure 4d: Distinguish between different medial lines. The different colors are only aids in showing the different lines.

DEFINITION 1 The **depth of a medial line** will be defined as $i-j$, where $i-j$ is the depth of the deepest edge in the network of resistors which the medial line intersects. The deeper the medial line, the larger the value of $(i + j)$.

How Medial Graphs/Lines Embed Information About the Network

Medial graphs/lines are extremely useful when analyzing electrical networks. Any networks which are the same will have the same medial graphs, so that behavior of the medial lines will tell you whether or not a network is completely recoverable from boundary measurements alone. There are two medial line formations important in determining whether or not a network is entirely recoverable: *lenses* and *self-intersections*. A *lens* is formed by two different medial lines intersecting each other twice, while a *self-intersection* is formed by a medial line intersecting itself, forming a closed loop. See

Figure 5. Only if medial lines form *lenses* or *self-intersections* is the network not entirely recoverable from boundary measurements alone. For the purposes, of this paper, however, only networks which are fully recoverable will be discussed.

To this extent, the most important feature about the medial graphs is the way potential and current information of the network can be embedded in the medial graph.

As noted before, the medial graph isolates each interior and boundary node in its own cell. To each of these cells, a number can be associated to represent the potential at the corresponding node. See **Figure 6**. In the remaining cells not associated with nodes, there is assigned a "circular current," to which there is associated a counter clockwise rotation (e.g. the "**J**" cells in **Figure 6**). Each "circular current" cell partially defines the current running conductors adjacent to it in the following way:

- 1) Choose a direction of current flow through the resistor adjacent to both "circular current" cells.
- 2) Subtract the "circular current" whose rotation arrow opposes this chosen direction from the one whose rotation arrow agrees with it.
- 3) This yields the current flowing in the desired direction through the conductor. See **Figure 6**.

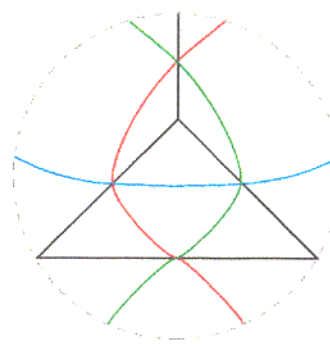

Figure 5a: A lens formed between the red and green medial lines. Lenses indicate that a set of edges are in series or in parallel. In this case there are two edges in parallel in an equivalent network.

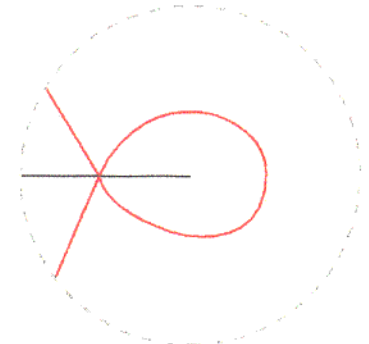

Figure 5b: A self-intersection. This occurs around an interior spike.

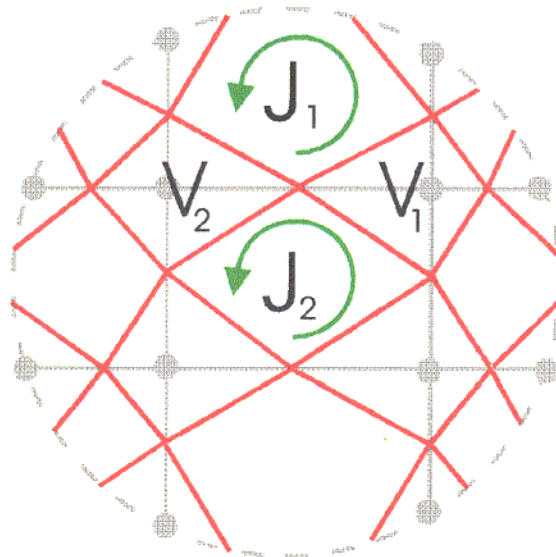

Figure 6: The current running from V_1 to V_2 is given by $J_2 - J_1 = (V_1 - V_2) \gamma_{12}$, where γ_{12} is the conductance of the adjoining edge.

Since all medial graphs are valence four, it is possible to arrange all current cells and voltage cells so they do not share an edge with a cell of the same type-- much like a checker board. See *Figure 7*.

Introduction to Landrum's Method

The technique of probing networks with Dirichlet and Neumann date to recover any resistor in a circular planar network by imposing only one set of boundary conditions (i.e. in one step) will hereby be referred to as *Landrum's Method*, after Joshua Landrum who first introduced the technique in his 1990 paper, "Three Algorithms for the Inverse Conductivity Problem." Since *Landrum's Method* allows us to recover *any* resistor in one step it has the advantages of being more accurate and faster when computing deep edges than other algorithms, which often require that other conductivities be recovered first. The main *disadvantage* is that *Landrum's Method* can only be applied to a very special family of networks, whose properties will be the main focus of this paper. Before saying more about these properties, an introduction to *Landrum's Method* is in order.

Consider the rectangular network in *Figure 8a, b*, where both the actual network and its medial graph are shown. In *Figure 8c*, imposed boundary voltages (their values depicted by numbers next to the nodes), imposed boundary currents (their values enclosed in parentheses), and their internal implications (the squiggly lines which represent zero current flow across the resistor and either a voltage of 1 or 0 at each node on that resistor if the lines are red or green respectively) are shown. (It may seem strange that both boundary currents and voltages may be specified, but this will be covered later.) These internal implications can easily be found using *Kirchhoff's Current Law*. (For Example: if a boundary potential and current of 0 are specified at a boundary node, it must be that the neighboring interior node must have a potential of 0. Further, any interior node with a potential 0, surrounded by three nodes with a potential zero, must have its fourth neighboring node be at potential 0.)

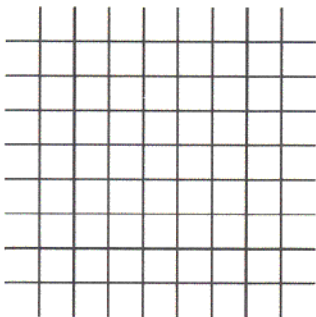

Figure 8a: Rectangular network

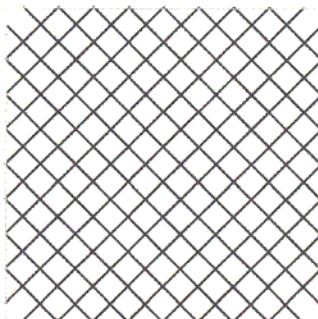

Figure 8b: The corresponding medial graph with border.

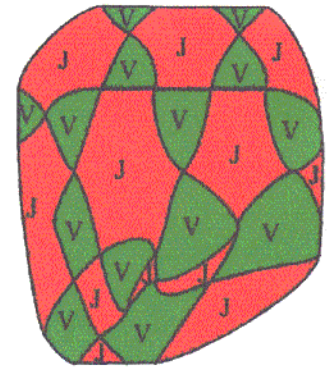

Figure 7: The medial graph from page three showing how voltage and current information can be embedded in it. Circular current cells are denoted with *J*'s while voltage cells are denoted with *V*'s. Note the added border around the medial graph formed by a topological disk intersecting the ends of each medial line helps to better define the boundary current and voltage cells. This type of boundary will be used in all medial graphs found in this paper.

The most important thing to notice about the setup in *Figure 8c* is that the network has effectively been divided into two parts, so that all the current flowing in from the top of network must flow through the blue conductor as it flows out the bottom of the network. Since both the voltage drop ($1 - 0 = 1$) and the current (which is equal to the current flowing in one end of the network) are known, it is easy to find the conductance of that conductor by *Ohm's Law*. Namely, it is equal to the current flowing across it:

$$\begin{aligned} I &= V\gamma \\ I &= (1 - 0)\gamma \\ I &= \gamma \end{aligned}$$

Thus, the conductance of a resistor buried deep within the network has been recovered in one step.

In **Figure 8d**, the corresponding situation is shown on the medial graph, with the corresponding imposed boundary conditions shown in white and their implications shown in black. Regions where there are potentials of one and zero current and where there are potentials of zero and zero current are shown by the red and green shadings, respectively. Note the current running from left to right through the blue resistor is known, being equal to $b - a$, which is the net current flowing in/out one end of the network.

DEFINITION 2: for the purposes of this paper, a *medial region* will be defined as a region representing zero current flow and known potentials in the medial graph which is imposed by boundary conditions alone.

Now, back to the question as to why both Dirichlet and Neumann data can be specified. In general, one can specify as many boundary voltages and boundary currents as there are boundary nodes (e.g., if there are ten boundary nodes, 5 voltages and 5 currents could be specified). However, caution must be exercised, since not all combinations of currents and voltages will work together. Consider the case of a rectangular network (as in **Figure 8a**), where the right to impose as many conditions as possible is exercised by specifying a current of 1 at every boundary node. Clearly, this can not work as there would only be current flowing *into* the network, violating *Kirchhoff's Law*. For clarity's sake, the following definitions will be used:

DEFINITION 3: Any boundary node with imposed potential and current conditions will be called an *alpha-node*.

DEFINITION 4: Any boundary node with unknown current and potential will be called a *beta-node*.

Let us investigate what happens when we impose current and/or voltage conditions, by looking at the case depicted in **Figure 8c**. First, number the boundary nodes clockwise consecutively, starting at the upper right-hand node (the $0(0)$ alpha-node) as number 1. Then impose one extra voltage condition at node 8 so that its potential is 0 (the reason for this will be clear later). Let v_i represent the voltage at the i^{th} boundary node. Then relation

$$\Delta\phi = \theta$$

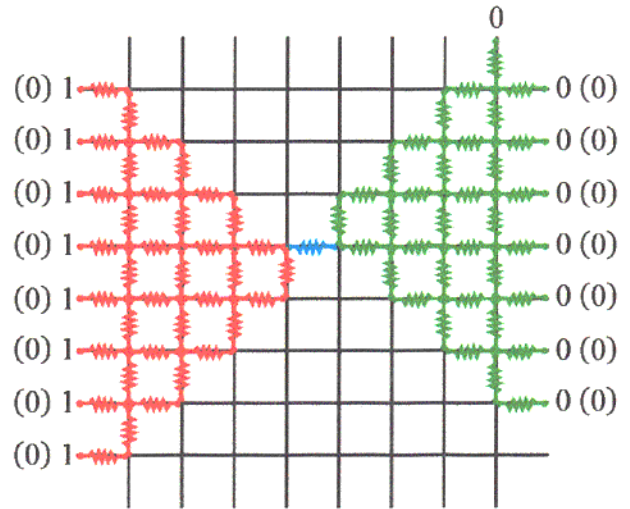

Figure 8c: The imposed Dirichlet and Neumann conditions set up regions of zero current and known voltage (proven by Kirchhoff's Law) which act to separate the network into two parts, so that all current flowing in the top of the network must flow through the isolated blue resistor. Since both the current flow and voltage drop across the resistor are known, its conductance can be easily found using Ohm's Law.

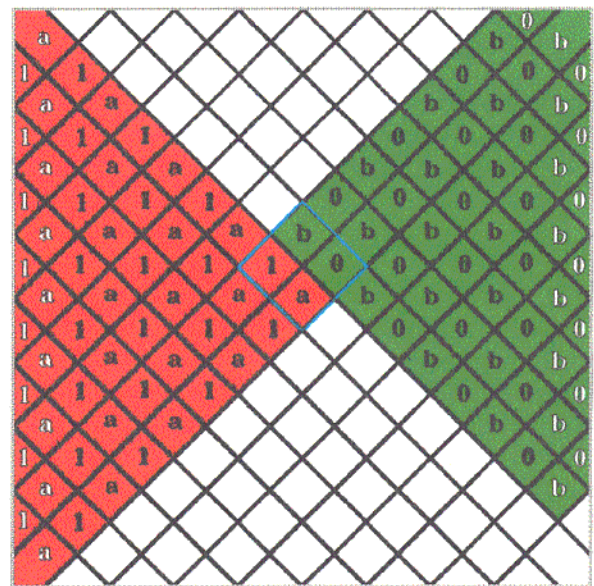

Figure 8d: The same situation shown in the medial graph. Imposed Dirichlet and Neumann data are shown by a white fill. The colored sections mark regions of known (zero) current flow and known voltages. Note the region outlined in the blue square, which corresponds to knowing the current and voltage drop across the blue resistor above. This type of touching between medial regions is the key to Landrum's Method.

yields the following system of equations:

$$v_9 I_{i,9} + v_{10} I_{i,10} + v_{11} I_{i,11} + v_{12} I_{i,12} + v_{13} I_{i,13} + v_{14} I_{i,14} + v_{15} I_{i,15} + v_{16} I_{i,16} + I_{i,17} + I_{i,17} + I_{i,18} + I_{i,19} + I_{i,20} + I_{i,21} + I_{i,22} + I_{i,23} + I_{i,24} + v_{25} I_{i,25} + v_{26} I_{i,26} + v_{27} I_{i,27} + v_{28} I_{i,28} + v_{29} I_{i,29} + v_{30} I_{i,30} + v_{31} I_{i,31} = 0$$

for $i=1, 2, 3, 4, 5, 6, 7, 17, 18, 19, 20, 21, 22, 23, 24$.

Although there are fifteen equations and fifteen unknowns, that does not guarantee a unique solution. However, there is a simple graphical technique to see whether a unique solution exists, but to prove this, a result from [1] must be used. Let T be a $m \times n$ matrix and let $Y=(y_1, y_2, \dots, y_k)$ and $Z=(z_1, z_2, \dots, z_k)$ be two sets of integers so that $1 \leq y_i \leq m$ and $1 \leq z_i \leq n$. Then $T(Y;Z)$ is the sub-matrix formed by the entries in the rows Y and columns Z of T .

Let Γ be a connected graph with a boundary (Γ need not be planar). Let I denote the set of interior nodes. If p and q are two boundary nodes, a **path** from p to q through Γ is a sequence of edges $(p, r_1), (r_1, r_2), \dots, (r_m, q)$ in Γ where the r_j are distinct interior nodes. Suppose $P = (p_1, \dots, p_k)$ and $Q = (q_1, \dots, q_k)$ are two disjoint sets of boundary nodes. A **connection** from P to Q through Γ is a set $\alpha = (\alpha_1, \dots, \alpha_k)$ of disjoint paths through Γ , where for each $1 \leq i \leq k$, α_i is a path from P_i to $Q_{\alpha(i)}$, and τ is an element of the permutation group S_k . Let $C(P;Q)$ be the set of all connections from P to Q . For each $\alpha = (\alpha_1, \dots, \alpha_k)$ in $C(P;Q)$, let:

- 1) τ_α be the permutation of (q_1, q_2, \dots, q_k) which occurs at the endpoints of the paths $(\alpha_1, \dots, \alpha_k)$;
- 2) E_α be the set of edges in α ;
- 3) J_α be the set of interior nodes which are not the ends of any edge in α .
- 4) K be the $N \times N$ (N is the number of interior and boundary nodes) *Kirchhoff Matrix*, which is similar to Λ , but maps boundary and interior voltages to boundary and interior currents as (also based on *Ohm's Law*):

$$K\vartheta = \Theta$$

Where ϑ and Θ are $N \times 1$ column vectors where ϑ_i is the voltage at the i^{th} node and Θ_i is the resulting current *out* of the i^{th} node. Every principle submatrix of K is positive definite.

- 5) $\gamma(e)$ represents the *conductivity* of the resistor corresponding to edge e .

Lemma 1 (from, and proven in, [1]). *Let (Γ, γ) be a connected resistor network. Let $P = (p_1, p_2, \dots, p_k)$ and $Q = (q_1, q_2, \dots, q_k)$ be two disjoint sequences of boundary nodes. Then*

$$\det \Lambda (P;Q) \cdot \det K(I,I) = (-1)^k \sum_{\tau \in S_k} \text{sgn}(\tau) \left\{ \sum_{\substack{\alpha \in C(P;Q) \\ \tau_\alpha = \tau}} \prod_{e \in E_\alpha} \gamma(e) \cdot \det K (J_\alpha; J_\alpha) \right\}$$

This result yields the following theorem:

Theorem 1. Suppose Γ is a circular planar resistor network and $(P;Q) = (p_1, \dots, p_k; q_1, \dots, q_k)$ are a set of pairings between boundary alpha-nodes and beta-nodes. Then, if $(P;Q)$ are connected through the interior with only one permutation of pairings of the p_i 's and q_i 's, then the imposed conditions yield no contradictions and are legal.

Proof: Since $\mathbf{K}(I,I)$ is positive definite, $\det \mathbf{K}(J,J) > 0$ for all $J \subseteq I$. Also, since $\gamma(e) > 0$, it follows that $\det \Lambda(P;Q) \neq 0$ if there is only one permutation of (q_1, q_2, \dots, q_k) determined by a connection. Thus $\Lambda(P;Q) \varphi_{(P)} = \theta_{(Q)}$ always has a unique solution. \square

A useful tool for checking to see whether or not alpha-nodes can be uniquely paired with beta-nodes is the technique of **reducing the network**. When it is asked whether or not imposed current and voltage conditions can exist in a network, it is really being asked whether or not there is a set voltage patterns such that *Kirchhoff's Law* is not broken in remaining part of the network (i.e., the part not directly affected by the conditions in question). To answer this, first remove all edges in the network which have specified currents across them (e.g. no current). Then define boundary nodes for the **reduced network** as any remaining nodes which were either original boundary nodes or any original interior nodes with a known potential (note that beta-nodes will never be removed). The latter type of boundary nodes for the reduced network will have imposed upon them the condition that zero current runs through them, since they were originally interior nodes. For an example based on the previous rectangular network, see **Figure 9**.

Since reducing the network removes edges, it cuts down on the number of possible non-intersecting paths connecting alpha- and beta- nodes, so it is easier to see if permutations of connectivity are unique. Another benefit to examining a reduced network is that excessive boundary current specifications in the original network are revealed. Because only the reduced network alpha-nodes need to be paired with beta-nodes (which are the same for both the original and reduced networks) to show that the set of boundary specifications in the original network is legal, it must be that the alpha-nodes in the original network can be paired with the alpha-nodes in the reduced network. Thus, there need only be the as many alpha-nodes in the original network as there are in the reduced network. **Example:** In **Figure 8c**, node 32 could have been specified as a 0 (0) alpha-node without affecting the interior implications of the imposed boundary conditions. However, nodes 1 and 32 could not be paired to beta-nodes via non-intersecting paths, leaving the question as to whether or not the boundary specifications were legal open. But whether or not nodes 1 and 32 are both specified as alpha nodes does not matter when examining the reduced network. In either case the reduced network only has 15 alpha-nodes, showing that there only needs to be 15 alpha-nodes in the original network (which is indeed the case).

These two properties of reducing graphs allows for the proof of the following theorem:

Theorem 2. Any square, rectangular network (with boundary spikes) can be entirely recovered using Landrum's Method, regardless of the size of the network.

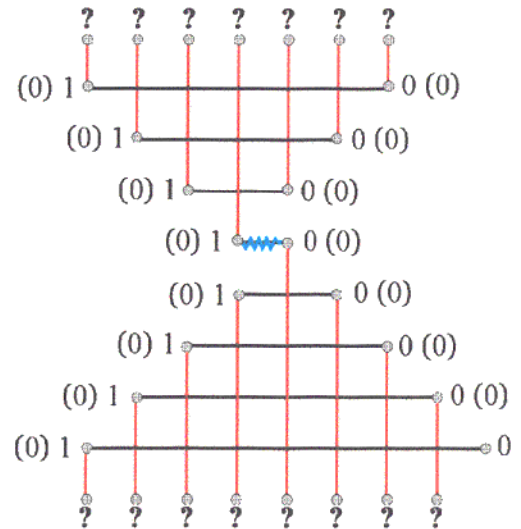

Figure 9: The reduced network of the of the previous rectangular case. It is sufficient to ask whether or not this pattern of currents and voltages is non-contradictory in the reduced network to determine if the original patterns of currents and voltages were non-contradictory in the original network. The red lines show how each alpha-node is uniquely paired with a beta node via non-intersecting paths. Thus, the imposed current and potential conditions are non-contradictory in both the original and reduced networks.

Proof: Let N be the layer of the square rectangular network (with spikes), R . Further, let w be the width of R , equaling the number of boundary nodes along one edge. Then:

$$N \leq (w + 1) / 2$$

Let P equal the number of boundary conditions (i.e. the number of specified potentials and currents) needed to imply known voltage and current conditions to the innermost layer. Then

$$\begin{aligned} P &= 2(N + (N - 1)) \\ &\leq ((w + 1) + (w - 1)) \\ &= 2w \end{aligned}$$

Notice the number of available boundary conditions needed to penetrate to the deepest layer twice (once from each side of the network) is less than or equal to the total number of boundary nodes, $4w$. Thus, there are always enough boundary conditions available to impose the desired potentials on the deepest resistors. It is easy to see by reducing the graph that these conditions are also legal.

Whenever *Landrum's Method* is used to penetrate to the center of a square network, the medial graph will resemble that in **Figure 10a**. Note that regardless of the size of the network, in the reduced network, all alpha-nodes will be paired uniquely to beta-nodes and thus the boundary conditions necessary to create these medial regions are legal.

Recovering other resistors in the network using *Landrum's Method* corresponds to setting up medial regions as in **Figure 10b**, which can be interpreted as the result of shifting the medial regions necessary for recovering the deepest resistors. Note that as the medial regions shift, the blue lines showing the unique pairings of all the alpha-nodes with beta-nodes shift with them so that boundary conditions necessary for creating these other medial regions are also legal. Thus any rectangular network with boundary spikes is recoverable using *Landrum's Method*, regardless of its size. The proof for a square network without boundary spikes is similar. \square

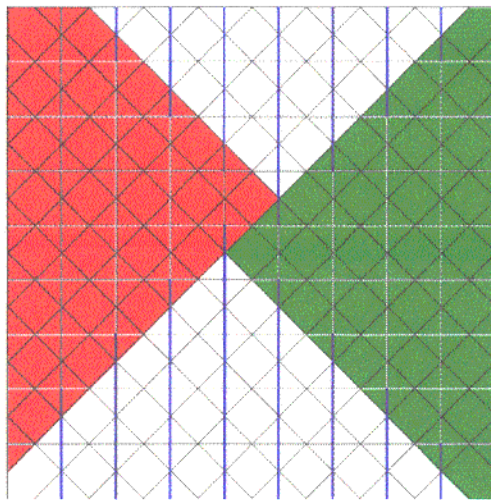

Figure 10a: Note the shape of the reduced network resulting from penetrating to the center of a square network using Landrum's Method is such that all alpha-nodes are uniquely paired with beta-nodes via non-intersecting connections (the blue lines).

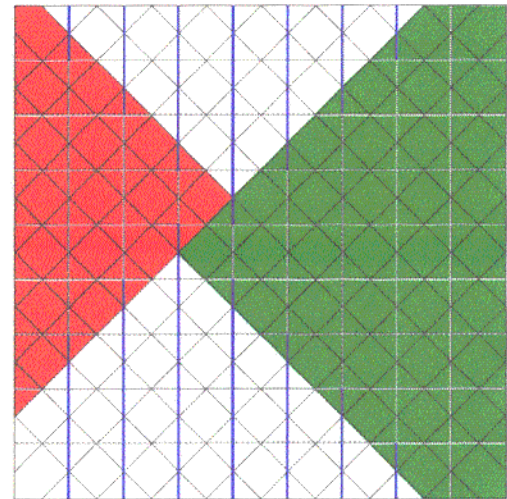

Figure 10b: When other resistors are recovered, the medial regions representing such a recovery are merely the result of shifting the medial regions required for the Landrum-recovery of the deepest resistors. Note that as the medial regions shift, the blue lines showing the unique pairings of alpha-nodes and beta-nodes in the reduced network shift with them so that the boundary conditions must be legal by Theorem 1.

Hexagonal Networks

Aside from rectangular networks, certain hexagonal networks can also be entirely recovered using *Landrum's Method*, such as the level two hexagonal network shown in **Figure 11a**. An example of the boundary conditions needed to recover the conductivity of a deep resistor is shown in **Figure 11b**. Note the shapes of the medial regions. The touching edges of each region consist of a voltage cell surrounded by two current cells--they are each three cells long. In fact, for *Landrum's Method* to work in hexagonal networks, the touching edges of the medial regions must always be no more than three cells long, otherwise internal contradictions arise. In **Figure 11c** the red medial region has been extended (depicted by the yellow addition) so that its touching edge is longer than three cells. Note how A, B, and C determine X. Now A, D, and X determine Y, but so do C, E, and X, which leads to a contradiction, and hence the medial regions cannot exist together. Another way to see if adjacent medial regions lead to contradictions is by looking at the "star" (shaded blue in **Figure 11c**) formed by the current cell adjacent to the voltage cell wedged between the two medial regions and all other voltage cells also adjacent to it. If more than one of the points of the star intersects the medial regions (as in **Figure 11c**), then there will be contradictions. Otherwise there will be none (at least not nearby...). This star feature also exists for other networks (such as the heptagonal network, q.v.).

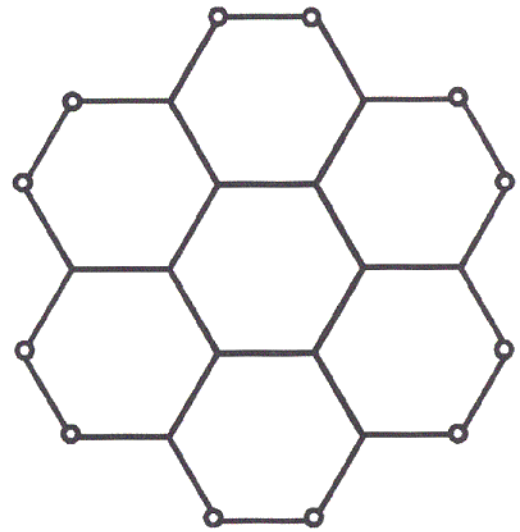

Figure 11a: A level two hexagonal network. Boundary nodes are marked with dots.

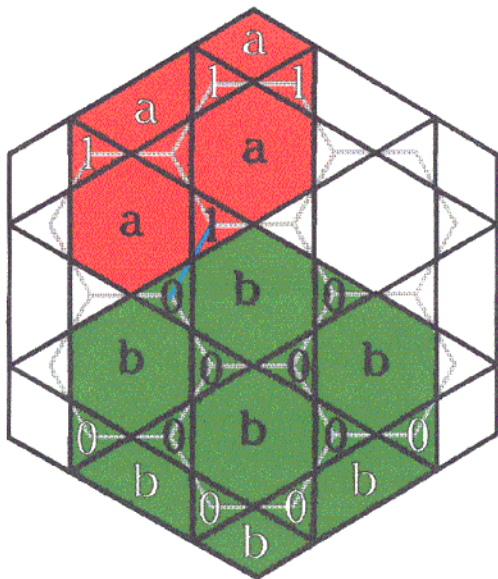

Figure 11b: An example of recovering a level 2-2 conductor (blue). Imposed boundary conditions are those with a white fill.

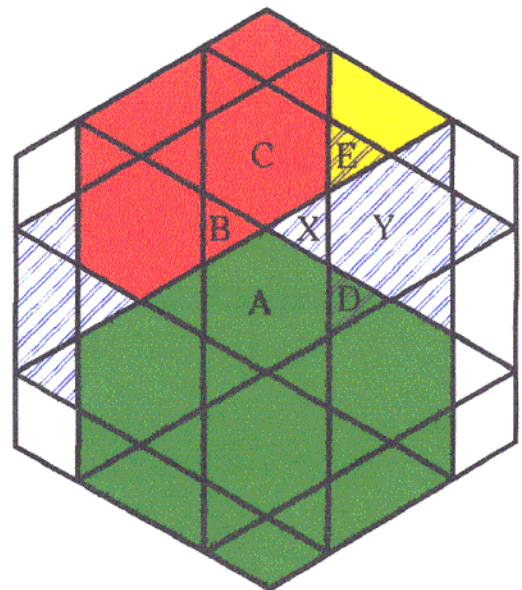

Figure 11c: Hexagonal networks must have no larger than three-sided (i.e. 2 current cells surrounding a voltage cell) edges which touch. Otherwise an illegal contradiction results. A, B, and C determine the value X. Then Cells A, X, and D determine Y. However, C, X, and F also determine Y, so there is a contradiction. For a network to have non-contradictory medial regions, a "star" must be formed with only one point existing in either region.

Although *Landrum's Method* works for recovering small hexagonal networks such as in **Figure 11a**, any hexagonal networks of level greater than two cannot be entirely recovered, such as the level three network in **Figure 12a**.

This network is too large to create medial regions with length-three edges deep within the network. Only edges that can be reached by imposing boundary conditions such that not more than one 0-0 edge (or *corner*) has an alpha-node specified per medial region can be recovered.

Figure 12b shows what happens when more than four corners have alpha-nodes imposed on them. Since all medial regions must be convex, the medial region will never have a edge less than the length of one of the sides of the network, which in this case is greater than three cells. Thus, the desired length three edge cannot be made by specifying alpha-nodes at more than four corners.

Similarly, no more than three corners can have alpha-nodes placed on them, as shown in **Figure 12c**. Again, in order for the medial region to be convex, it must have sides longer than three cells, making the region useless.

Following the same reasoning, there can't be two or more corners with alpha-nodes on them. See **Figure 12d**. Using this information, it is easy to determine whether or not a resistor could be recovered using *Landrum's Method*. See **Figure 12e**. In order to do so, simply set up the desired medial regions, keeping in mind that they both need to be convex and need to touch along edges that are of length three or less (look for the star). If either of these desired medial regions indicates that more than one corner must have alpha-nodes specified on it, then the region is bogus and cannot be set up.

However, just because the resistor can't be recovered by one medial region does not mean it can't be recovered by another medial region. This is the case in **Figure 12e**. Since medial graphs are 4-valent, there are always *two* ways to isolate a resistor—each one using one of the two medial lines passing through the resistor to act as the barrier between the two regions. In **Figure 12e**, the resistor *can* be recovered if the alternate medial regions are used. **Figure 13** shows which resistors can and cannot be recovered using *Landrum's Method*. More will be said about this later in the paper.

Theorem 3. Only level two and smaller hexagonal networks such as in figure 11a can be recovered entirely using Landrum's Method.

Proof: Let n be the number of complete hexagons intersected by a ray originating from the central hexagon of a hexagonal network, perpendicular to one of its edges (e.g., in **Figure 12a**, $n = 2$). Further, let N be the depth of the network, and B be the number of boundary nodes. Then,

$$\begin{aligned} N &= 2n \\ B &= 6(n + 1) \end{aligned}$$

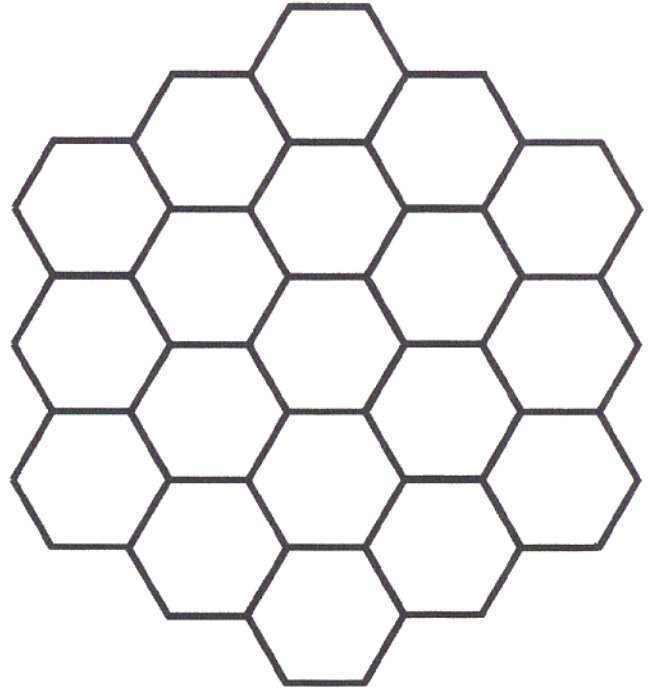

Figure 12a: A Level four hexagonal network cannot be entirely recovered with Landrum's Method.

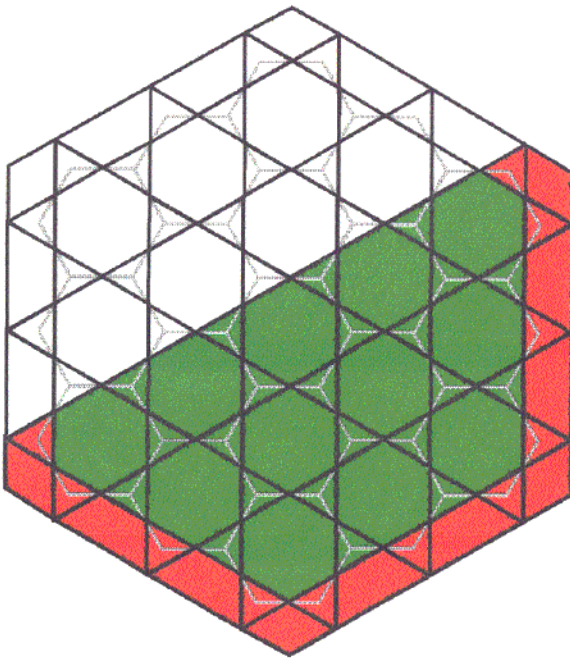

Figure 12b: The red region represents imposed conditions and the green region shows their implications. Since medial regions must be convex, specifying alpha-nodes at four or more corners results in a region with an available edgelonger than three cells, and is thus useless in Landrum's Method.

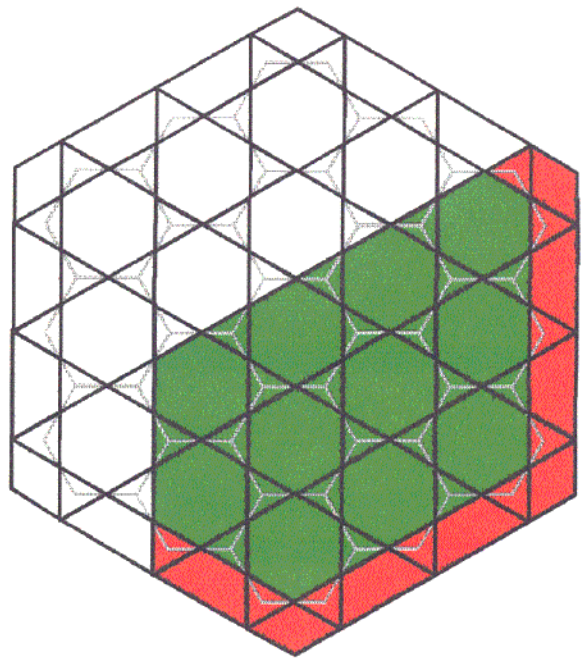

Figure 12c: Similarly, there cannot be three or more corners with alpha-nodes placed on them, otherwise all of the edges of the medial region will be longer than three cells, making them useless. Again, the red region represents imposed boundary conditions while the green region represents their implications.

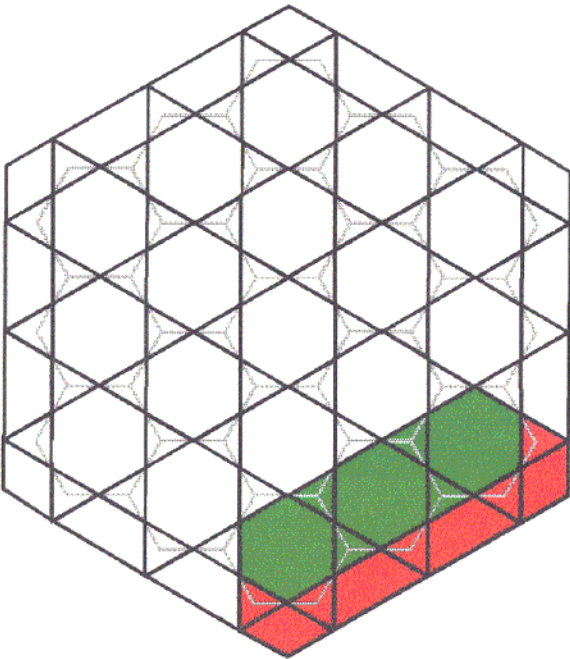

Figure 12d: Even if as few as two corners have alpha-nodes on them, the medial region will yield edges of length greater than three. Note that on the ends there are two edges of length two, but these could be more easily specified by placing potential conditions at each corner, and thus the extra conditions used in this case do not act to create a medial region that could penetrate the network any deeper than could be achieved with fewer boundary specifications.

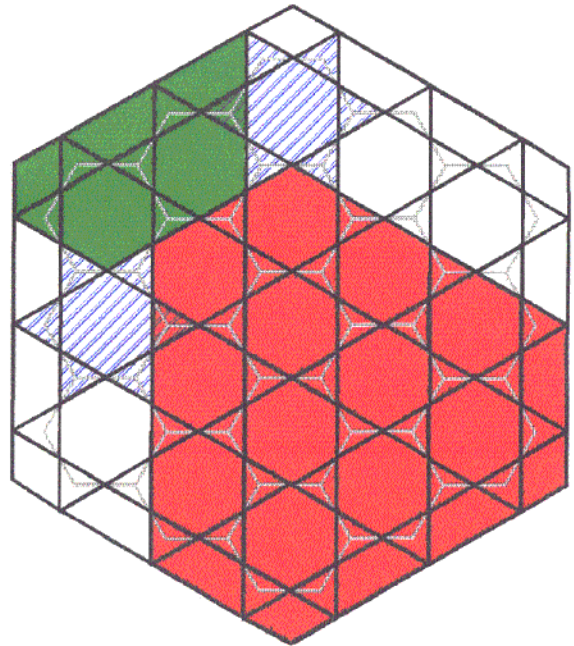

Figure 12e: Using the previous information, it is easy to tell whether or not a resistor can be recovered with Landrum's Method. First, the desired edges along the resistor are set up (note the stars) and then the smallest convex regions are made to fit these sides. If either of these regions indicates that alpha-nodes must be specified at more than one corner, then the desired regions cannot be setup and the resistor cannot be recovered. Note that in this case, the red region covers more than two corners, and thus the resistor in question cannot be recovered with this kind of medial region. However, this resistor can be recovered by approaching it in a different way.

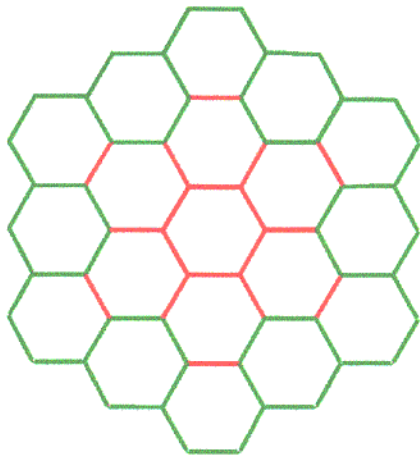

Figure 13: A graph showing which resistors can (green) and can't (red) be recovered with Landrum's Method. Notice how the level 2-2 resistors can't be recovered, although all of their neighbors can.

Now, the number of boundary conditions which need to be specified in order to reach the innermost node (i.e. number of imposed potentials and number of imposed currents) is:

$$2N = 4n$$

To probe to the center, one medial region must reach the innermost layer while the other must reach it and go one step further, so that the required boundary conditions needed to isolate a level N-N resistor:

$$4n + 4n + 2 = 8n + 2$$

However, the number of imposed boundary conditions cannot be greater than the number of boundary nodes, so it must be that:

$$\begin{aligned} B &\geq 8n + 2 \\ 6n + 6 &\geq 8n + 2 \end{aligned}$$

$$n \leq 2$$

Thus, regardless of whether or not they are legal, just to be able to get the proper potentials specified in the center requires a layer four network or smaller. But as was just shown, a layer four network cannot be probed because specifying those voltage conditions cannot be done legally. Therefore only hexagonal networks of level 2 or less can be entirely recovered using Landrum's Method. □

Hexagonal Networks with Boundary Spikes

Because only a hexagonal network (without spikes) of layer two or smaller can be entirely recovered, it is natural to conjecture that a hexagonal network with boundary spikes (or spiked hexagonal network) such as in Figure 14 cannot be recovered unless it is a level one network. This assumption is correct and easily proven using the same node counting techniques used previously:

Let n , N , and B be defined as they were in the proof for Theorem 3. Then, for a spiked hexagonal network,

$$\begin{aligned} N &= 2n + 1 \\ B &= 6n + 6 \end{aligned}$$

Now, the number of boundary conditions which need to be specified is to isolate a level N-N resistor is:

$$(4n + 2) + (4n + 4) = 8n + 6$$

For this to be less than or equal to the number of boundary nodes, $n = 0$. Thus, the spiked hexagonal network can be no deeper than one layer.

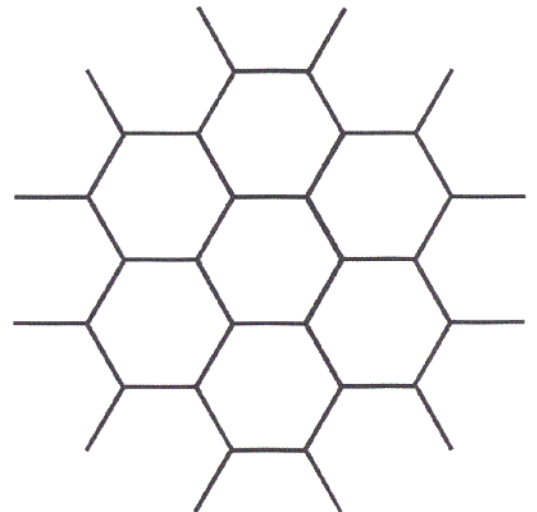

Figure 14: A level three spiked hexagonal network. This network cannot be entirely recovered using Landrum's Method.

Other Hexagonal Networks

Besides the hexagonal networks previously discussed, there are other types of networks based on hexagonal tilings which can be completely recovered using *Landrum's Method*, such as the **triangular hexagonal networks** depicted in **Figure 15a, b**. These two examples are both entirely recoverable using *Landrum's Method*. **Figures 15c, d** show examples of recovering the deepest resistors in the networks. Another level 3 triangular hexagonal network (this one with a hexagon center rather than a node) which cannot be recovered with *Landrum's Method* is shown in **Figure 16a**, with an example of the problems that arise when trying to isolate a level 3-3 resistor. Note how the medial regions do not cut back sharp enough so that only one of the star's points intersects the medial regions. More will be said about this in the *Section X*.

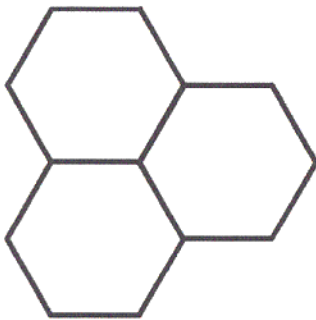

Figure 15a: A level two triangular hexagonal network can be completely recovered with Landrum's Method.

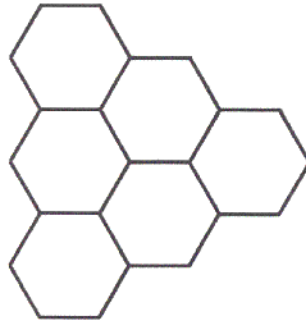

Figure 15b: A level three triangular hexagonal network can also be completely recovered with Landrum's Method

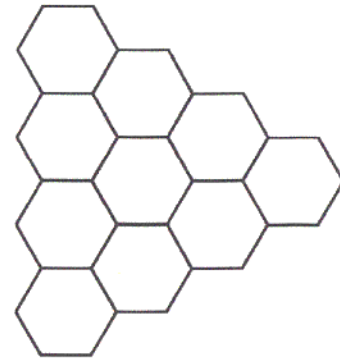

Figure 16a: A level three triangular hexagonal network which cannot be entirely recovered with Landrum's Method.

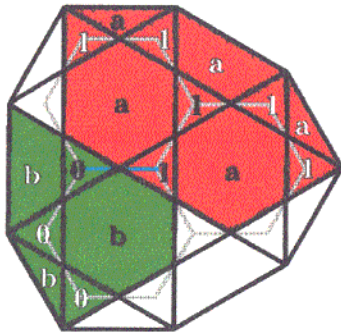

Figure 15c: Recovery of a level 1-2 resistor in a level 2 triangular hexagonal network. White indicates imposed boundary conditions.

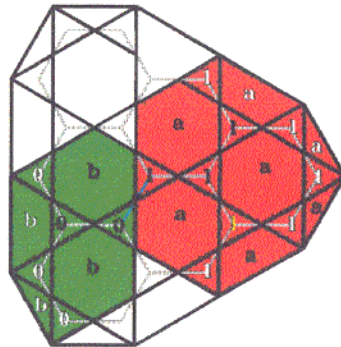

Figure 15d: Recovery of a level 2-3 edge in a level 3 triangular hexagonal network. White indicates imposed boundary conditions. Note: the yellow potential was determined to be 1 as all of its neighbors were found to be at potential 1.

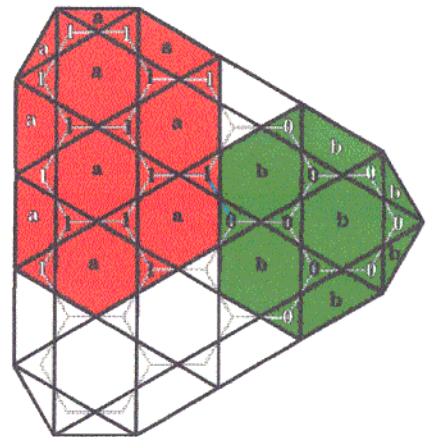

Figure 16b: An example of how recovery of the deepest layers cannot be done. White indicates imposed boundary conditions. Note the star region on the top has two tips inside the medial regions, indicating that the boundary conditions are illegal. Attempted Landrum-recovery in another way leads to the same difficulties.

Circular Networks

DEFINITION 5. A circular network (*Note: not a circular planar network*) of type $C(m,n)$ is composed of $m \geq 1$ circles and $n \geq (4m + 3)$ rays. *Example: Figure 17a* is a $C(2,11)$ network.

Unlike the other types of networks examined so far, circular networks of type $C(m,n)$ cannot be recovered with *Landrum's Method*, regardless of their size. *Figure 17b* shows the problem involved in probing the network. Note how the two medial regions touch along very long edges, causing many contradictions.

These medial regions are typical in of circular network. If the medial region contains the center cell (corresponding to the node of degree $m + 1$), two edges (the "radial edges") are each defined by a single medial line. If the medial regions do not contain the central cell, the two "radial edges" are each defined by a single medial line up until a level 0-1 edge.

Therein lies the problem in using *Landrum's Method* to recover a circular network. *Figure 18* shows the central section of a circular network and the corresponding medial regions which must be imposed in order to recover an $m - (m + 1)$ resistor. Since one of the "radial edges" of each medial region is defined mostly or entirely by the single medial line running through the isolated resistor, they will touch along that line up a 0-1 edge, thus causing many contradictions. Therefore, a circular network of type $C(m,n)$ cannot be *Landrum*-recovered.

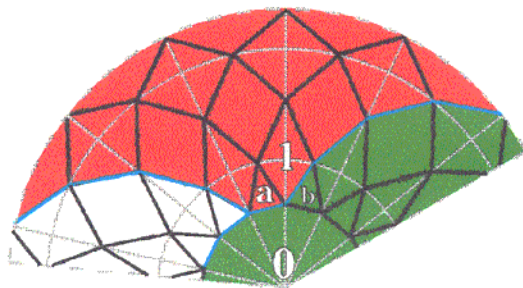

Figure 18: The central section of a $C(m,n)$ network. Note how required conditions for Landrum-recovery of a level $m - (m + 1)$ resistor lead to the two medial regions having contradictory contact since each touching edge is defined by the same medial line.

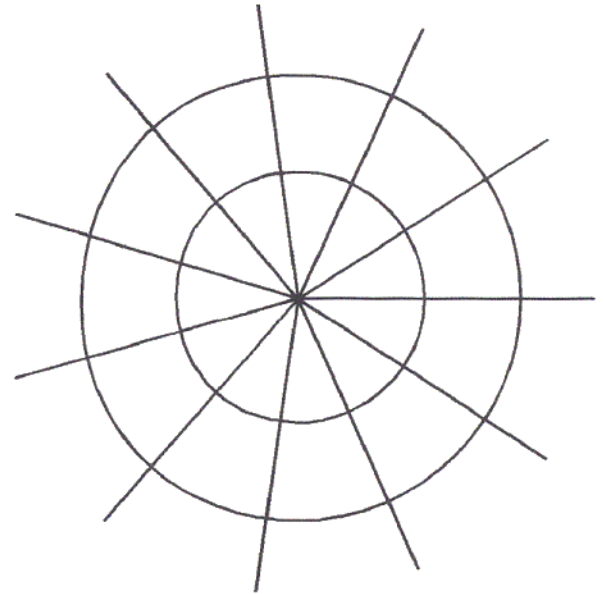

Figure 17a: A $C(2,11)$ Network.

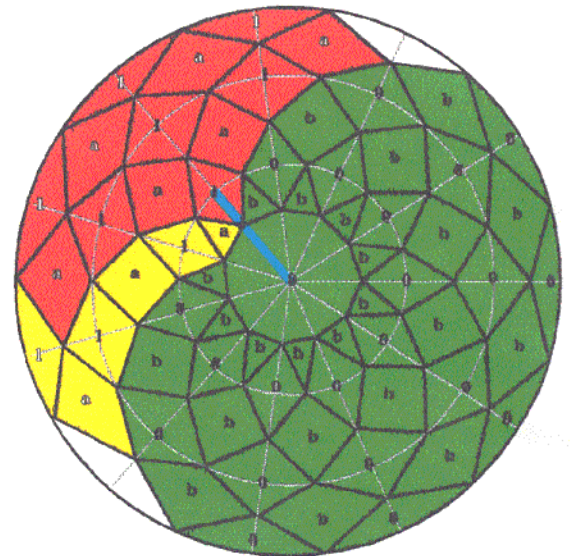

Figure 17b: Trying to recover the blue resistor. Note the long touching edges which lead to contradictions. The shape of the red region is typical of medial regions that do not contain the center cell. The green region's shape is typical of regions which contain the center cell. The yellow section is needed to specify the current running through the blue resistor. Note how specifying an extra alpha-node adds another "strip" to the medial graph, which is defined by two medial lines.

A Degenerate Circular Network

There are many other types of circular networks besides $C(m,n)$ -type. Particularly interesting is the type shown in **Figure 19a** in that the deepest edges can be *Landrum*-recovered while shallower ones cannot. **Figure 19b** shows which edges can and cannot be *Landrum*-recovered and **Figure 19c** shows a typical problem when attempting to *Landrum*-recover those edges: there is a contradiction since cell Y will be determined in two different ways.

In this case, the method of isolating a level 1-1 resistor has been chosen so that all central (level 1-2) resistors must have no current running through them (the alternate choice is even more problematic). The underlying reasons for the problems of *Landrum*-recovery of these edges are very similar to those for the $C(m,n)$ -type networks. Note how in both networks the two "radial edges" of each medial region are defined [entirely] by a single medial line. Although the two medial regions in this degenerate circular network do not touch all the way along these edges, they are close enough so that they do cause contradictions (i.e., the Y cell). In fact, because all 1-2 edges must have zero current running through them, it appears that it doesn't even matter how many extra level 0-1 edges are placed between the seven central spokes (i.e. the spokes formed by joining the seven intersecting level 0-1 and 1-2 edges) because at some point, recovery of one of the level 1-1 edges will force the two medial regions too close together, causing contradictions.

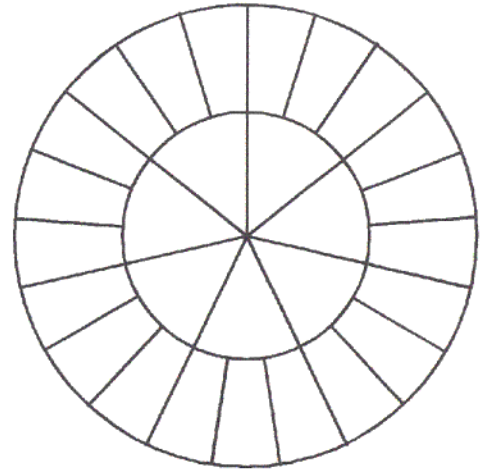

Figure 19a: A degenerate level 2 circular network.

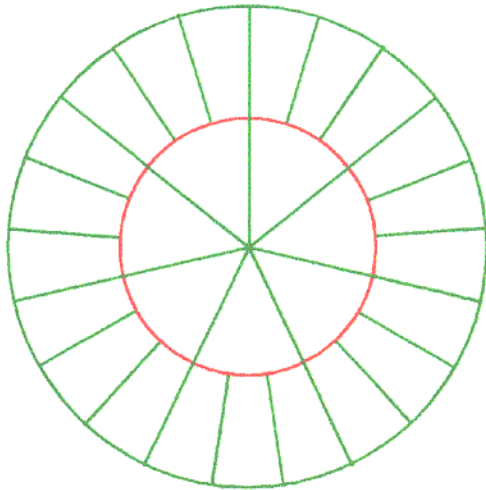

Figure 19b: Green resistors can be *Landrum* recovered while red resistors can't. An interesting feature of this network is that level 1-2 resistors can be *Landrum*-recovered while level 1-1 resistors cannot.

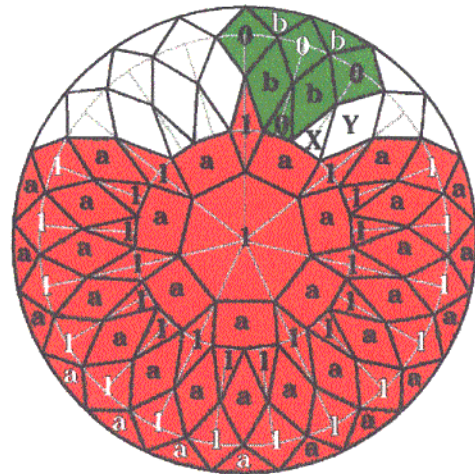

Figure 19c: A contradiction in the Y cell arise when trying to recover a level 1-1 resistor because the medial regions are too close together. This happens because each of the region's "radial edges" is defined mostly (or entirely) by a single medial line.

Heptagonal Networks

Perhaps the most interesting network discussed in this paper is the heptagonal network, an example of which is shown in **Figure 20a**. What makes it so interesting is, despite its complexity and size (it is a level five network), it can be completely recovered using *Landrum's Method*. Even a level seven heptagonal network can be *Landrum*-recovered. In fact, it seems that any size heptagonal network can be *Landrum*-recovered, although this speculation is not proven.

Figure 20b shows the medial graph corresponding to the recovery of a level 5-5 resistor. Notice how the problems that plagued the other networks do not appear here. Each region cuts away from the other quite sharply compared to the hexagonal and circular networks (in fact neither "stars" have any points intersecting the medial regions). The reason for these well behaved medial regions seems to be due in part to the complexity of the network itself.

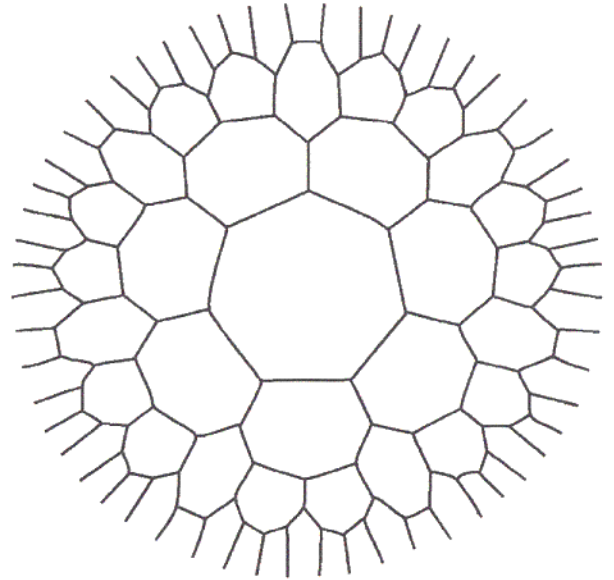

Figure 20a: Despite its size and complexity a level 5 (and even a level 7) heptagonal network can be completely recovered using Landrum's Method.

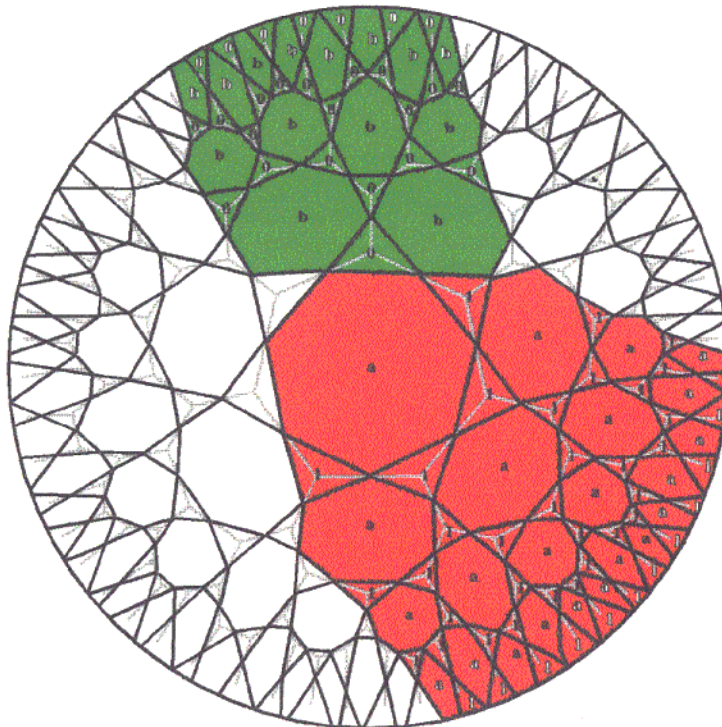

Figure 20b: Medial regions corresponding to the recovery of a level 5-5 resistor. Note how sharply each region cuts back away from the other, almost on the verge of being non-convex, unlike the medial regions of other networks. This turning away is so abrupt that even the "stars" do not have any points laying in the regions, indicating how internal implications of imposed boundary conditions can be isolated and controlled well. The reason for this desirable behavior seems to lie in the complexity of the network itself.

The complex configuration of the heptagonal network gives rise to many different types of medial lines—ones which sweep through the entire network, some which go midway in, and others which turn back out almost as soon as they entered. These different lengths of medial lines seem to be what is responsible for the ability of the medial regions to make such sharp turns.

Figure 21 shows the medial regions corresponding to the recovery of a different resistor. Marked in blue are the medial lines which act to define the medial regions. Notice how the large region is defined by four medial lines, two sides by level 5-5 medial lines, while on the other sides it is defined by shallower medial lines. The smaller region is also defined by four different medial lines—all of which are rather shallow. If the smaller region could not be defined by medial lines shallower than the lines which act to define the larger region, they would most likely end up touching along the longer lines for too great a distance, causing contradictions, as happens in other networks. The $C(m,n)$ -type circular networks are a most noticeable example of this behavior. See **Figure 22**.

In fact, there seems to be a strong correspondence between networks which have a wide variety of different depth medial lines and whether or not they are *Landrum*-recoverable. **Figure 23** shows the medial graphs of all of the different networks discussed and the different layers of medial lines.

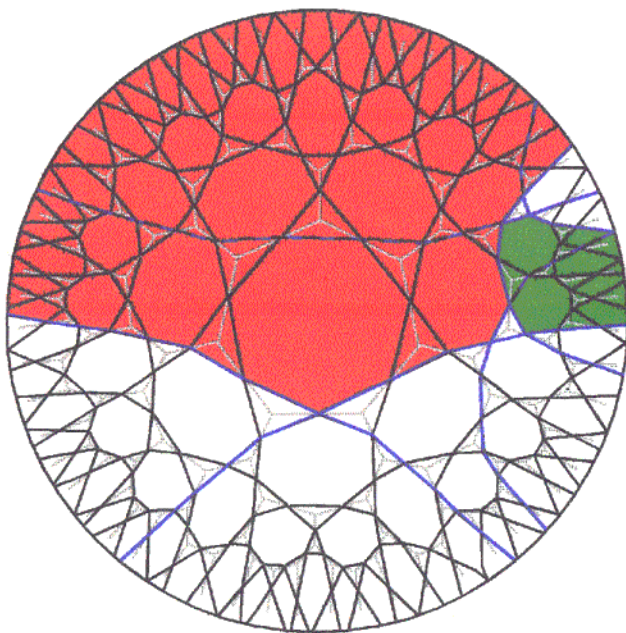

Figure 21: Medial regions corresponding to the recovery of a level 3-3 resistor. The blue lines correspond to the medial lines which act to define the edges of the medial regions. Note how the density of shallow medial lines allows the green region to cut back quite sharply, since it does not need to be defined by deep medial lines. If there weren't such a high density of shallow medial lines, both regions would be defined by deep medial lines, which would probably lead to them touching too much, causing contradictions. This is quite apparent in the circular network, where all medial lines have the same depth. See **Figure 22**.

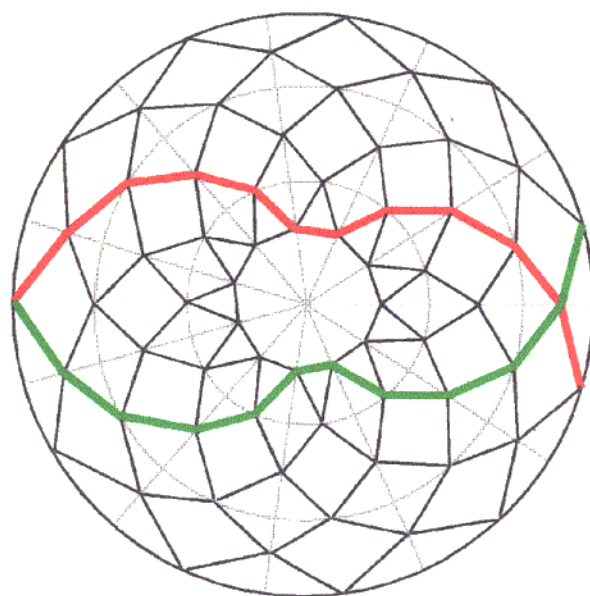

Figure 22: The medial graph for a $C(m,n)$ network. Notice how all medial lines are level $m-(m+1)$. As was shown before, this causes problems since all medial regions must be defined in terms of these medial lines. Thus if two regions are adjacent, both of their edges will be defined by the same medial line, causing them to touch too much, leading to contradictions.

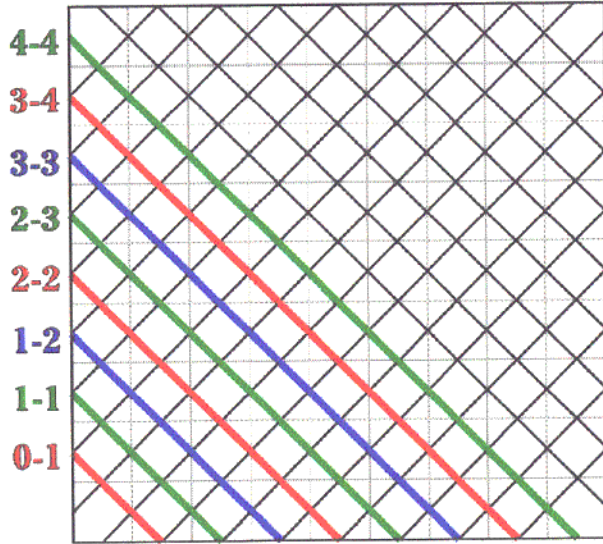

Figure 23a: A level eight rectangular network has eight levels of medial lines:

- 0-1
- 1-1
- 1-2
- 2-2
- 2-3
- 3-3
- 3-4
- 4-4

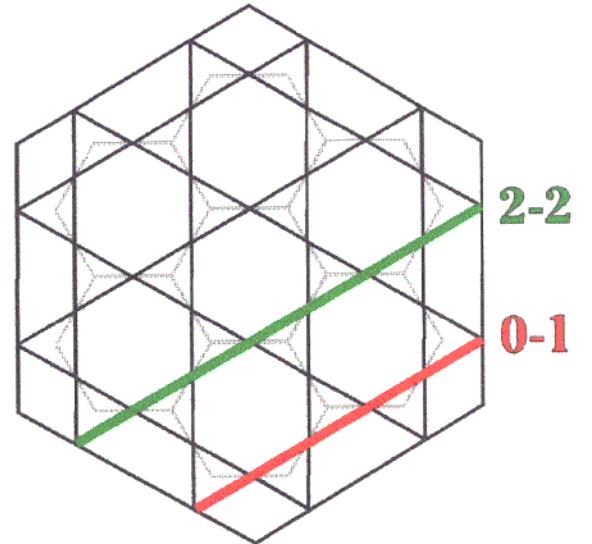

Figure 23b: A level two hexagonal network has two levels of medial lines:

- 0-1
- 2-2

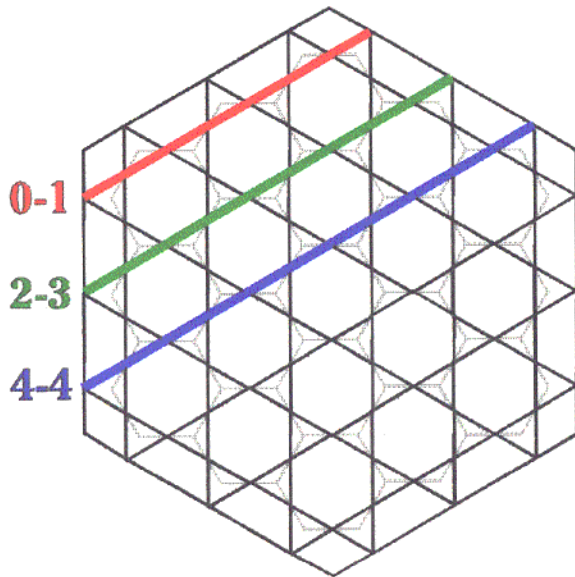

Figure 23c: A level four hexagonal network has three levels of medial lines:

- 0-1
- 2-3
- 4-4

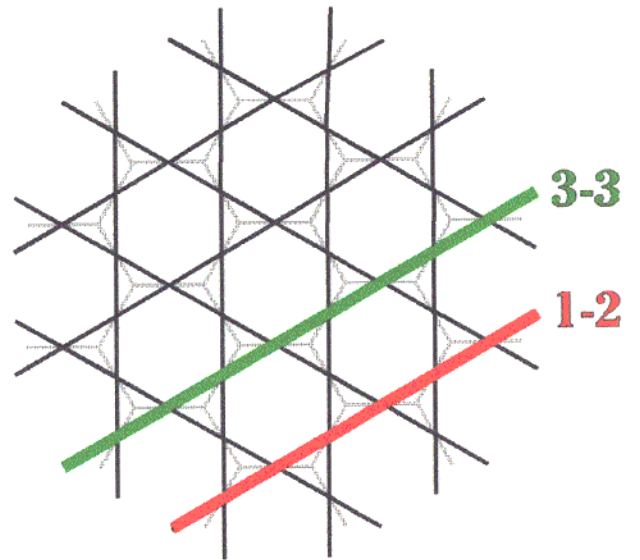

Figure 23d: A level three spiked hexagonal network has two levels of medial lines:

- 1-2
- 3-3

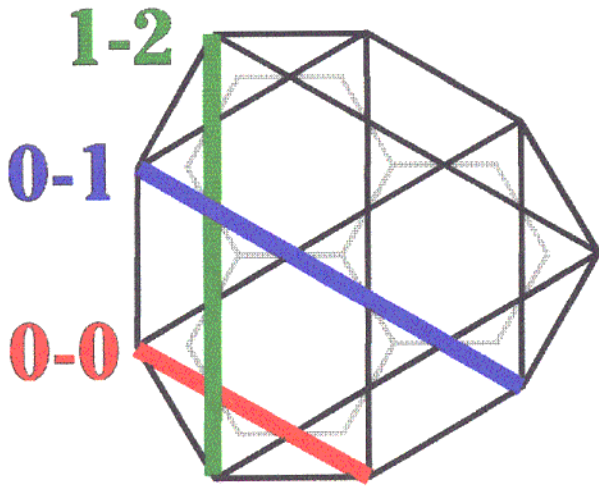

Figure 23e: A level two triangular hexagonal network has three levels of medial lines:

0-0
0-1
1-2

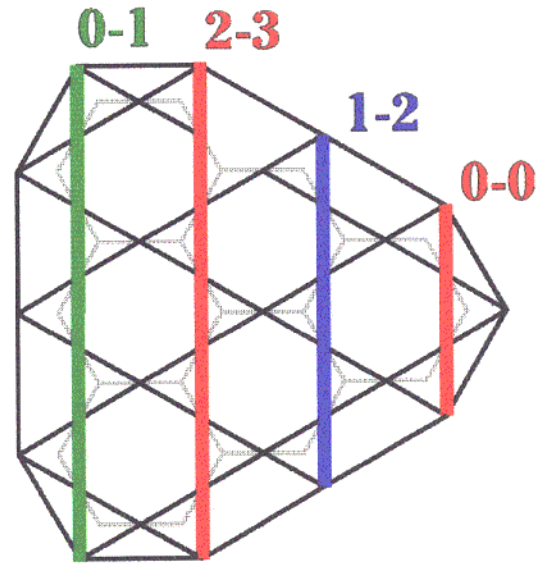

Figure 23f: A level three triangular hexagonal network has four levels of medial lines:

0-0
0-1
1-2
2-3

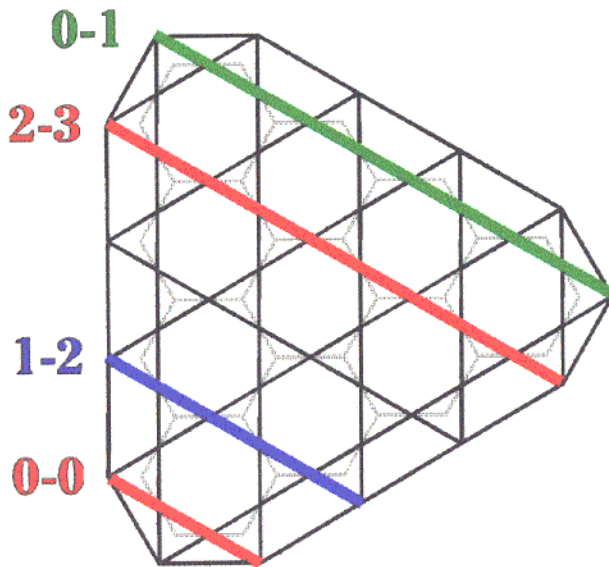

Figure 23g: An alternate level three triangular hexagonal network has four levels of medial lines:

0-0
0-1
1-2
2-3

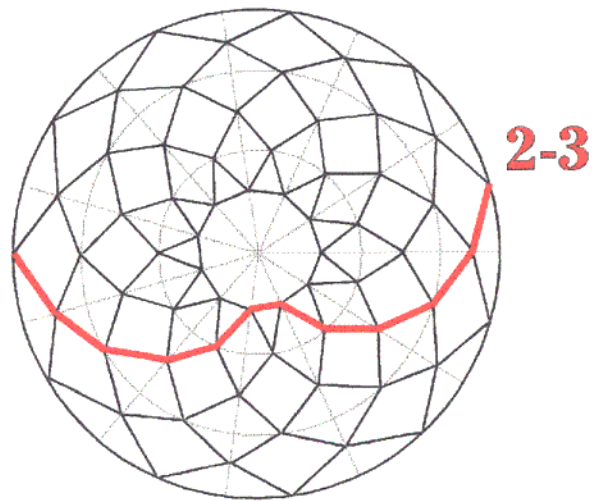

Figure 23h: A $C(2,11)$ network has only one level of medial lines:

2-3

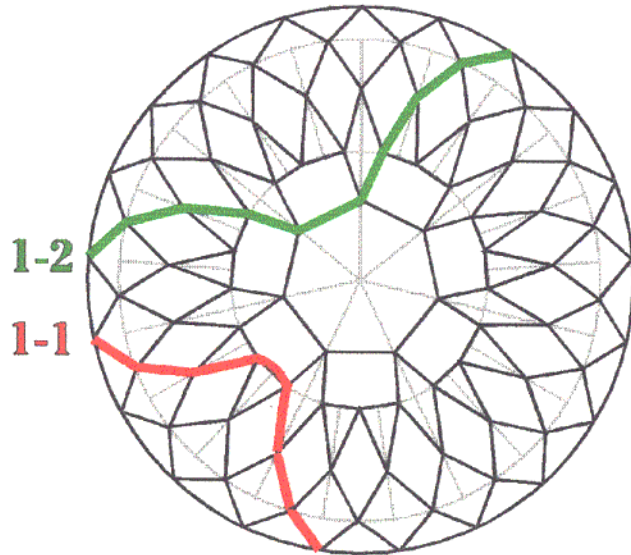

Figure 23i: A level two degenerate circular network has two levels of medial lines: 1-1, 1-2.

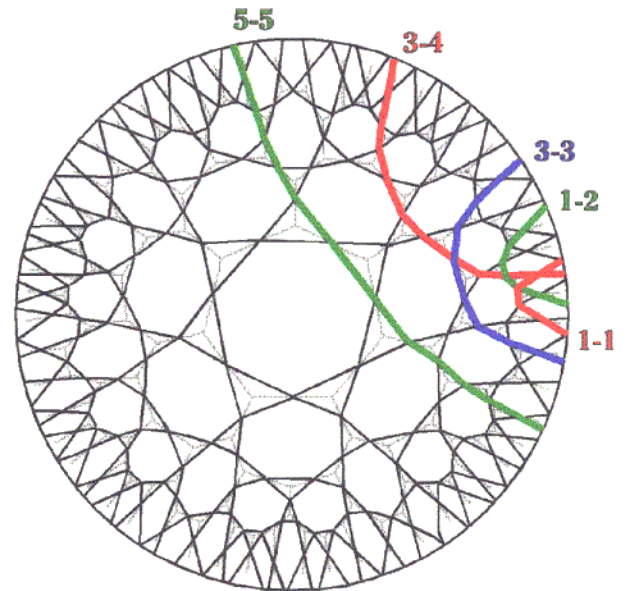

Figure 23j: A level five heptagonal network has five levels of medial lines: 1-1, 1-2, 3-3, 3-4, 5-5.

Table 1

Network Type	Label Letter	Depth of Edge	# of Medial Lines of Same Depth	Network Type	Label Letter	Depth of Edge	# of Medial Lines of Same Depth
Rectangular Network (level 4)	a	0-1	4	Hexagonal Network With Spikes (Level 3)	a	0-1	0
	b	1-1	4		b	1-1	0
	c	1-2	4		c	1-2	6
	d	2-2	4		d	2-3	0
	e	2-3	4		e	3-3	6
	f	3-3	4	Triangular Hexagonal Network (level 2)	a	0-0	3
	g	3-4	4		b	0-1	3
	h	4-4	4		c	1-2	3
Hexagonal Network (level 2)	a	0-0	0	Tirangular Hexagonal Network (level 3)	a	0-0	3
	b	0-1	6		b	0-1	3
	c	1-2	0		c	1-2	3
	d	2-2	6		d	2-3	3
Hexagonal Network (level 4)	a	0-0	0	Alternate Triangular Hexagonal Network (level 3)	a	0-0	3
	b	0-1	6		b	0-1	3
	c	1-2	0		c	1-2	3
	d	2-2	0		d	2-3	6
	e	2-3	6				
	f	3-4	0				
	g	4-4	6				

Table 1, continued

Network Type	Label Letter	Depth of Edge	# of Medial Lines of Same Depth
C(2,11) Circular Network (level 3)	a	0-0	0
	b	0-1	0
	c	1-1	0
	d	1-2	0
	e	2-2	0
	f	2-3	11
Degenerate Circular Network (level 2)	a	0-0	0
	b	0-1	0
	c	1-1	14
	d	1-2	7
Heptagonal Network (level 5)	a	0-1	0
	b	1-1	14
	c	1-2	21
	d	2-3	0
	e	3-3	7
	f	3-4	7
	g	4-5	0
	h	5-5	7

For each network, **Table 1** shows the different depths (or *types*) of edges it has and how many medial lines have that same depth. The column "Label Letter" provides an easy way to refer to each row.

Notice that all of the networks that can be *Landrum*-recovered have at least the same number of different depth medial lines as the networks are deep. For example, the level five heptagonal network has five different depths of medial lines, and the level four rectangular network has eight different depths of medial lines. Notice that nearly all of the networks that could not be *Landrum*-recovered lack this property. For example, the level four hexagonal network has only three different depths of medial lines.

The only exception to this is the alternate level three triangular hexagonal network which has four different depths of medial lines. However, there is not a great density of shallow medial lines, as seems to be required for *Landrum*-recovery. In fact, there are six of its deepest medial lines and only three of each of the other three shallower types (i.e., 40% of its medial lines are of its deepest type). It seems that although it is not as diabolical as the circular networks, it still has similar properties-- too many of its medial regions will be defined by these deep medial lines, leading to

contradiction. Thus, it might be reasonable to expect that not only would a network be required to have the same number of different depth medial lines as it is deep, but that the medial lines be arranged so that for a medial line of depth $i-j$, there would be at least the same number of medial lines of depth $k-l$, for each $k-l$ shallower than $i-j$.

This conjecture seems to hold for most cases, except the heptagonal network which has fewer 1-1 level medial lines than 1-2 level medial lines. Perhaps the number of $k-l$ depth medial lines need only be at least $X\%$ (e.g., 67%) of the number of $i-j$ medial lines for each $k-l$ shallower than $i-j$ and for some number X (which may or may not be a constant). An alternative explanation as to why this doesn't hamper the *Landrum*-recoverability of the heptagonal network is that it happens so close to the boundary. If the heptagonal network had all boundary spikes removed so that all level 1 nodes became boundary nodes, then there would be more level 0-1 medial lines than level 0-0 medial lines. A lack of 0-0 medial lines wouldn't cause any problems since boundary-level currents and potentials can be so easily controlled. This may be a viable interpretation since specifying a the proper boundary conditions required for *Landrum*-recoverability in either case (i.e., with or without boundary spikes) yields the same results. So the correct formulation may be that the medial lines be arranged such that for a medial line of depth $i-j$, there would be at least the same number of medial lines of depth $k-l$, for all $k-l$ shallower than $i-j$ and deeper than $m-n$, for $m-n$ near the boundary. The exact formulation seems rather slippery.

An intuitive argument for why there must be the same number of different level medial lines

follows:

DEFINITION 6: *There exists a **depth-correspondence** between a medial line and an edge if they have the same depth. Saying "there is a **depth-correspondence**" is equivalent to saying "there exists a depth-correspondence between a medial line and an edge."*

Note that all of the networks that could not be *Landrum*-recovered, except the alternate triangular hexagonal network, have a rather small number of different depths (or *types*) of medial lines as compared to the number of different depths (or *types*) of edges. For example, the level four hexagonal network has only three types of medial lines, but seven types of edges. In **Table 1**, it is clear that for the level four hexagonal network, only in rows *b*, *e*, and *g* is there a depth-correspondence. Rows *a*, *c*, *d*, and *f* do not have contain a depth-correspondence, and most notably, rows *c* and *d* are adjacent.

DEFINITION 7: *In an ordering of a network's edge types from shallowest to deepest, there exists an **X skip** if there are *X* consecutive edge-types which do not have a depth-correspondence. This is equivalent to saying that in **Table 1**, there are *X* consecutive rows which do not have depth-correspondence.*

DEFINITION 8: *The two types of edges which act to define the boundaries of an **X skip**, but are not themselves included in an **X skip**, are defined as the **skip-neighbors**.*

DEFINITION 9: *Any edge existing in the set of edges which comprise an **X skip** are called **skipped edges**.*

In every network which is not *Landrum*-recoverable, except in the alternate level three triangular hexagonal network, there exists a level two (or greater) correspondence skip, while in all *Landrum*-recoverable networks there exists either one skips (e.g. heptagonal network), or no skips at all (e.g., rectangular network).

How might this be interpreted? It might be that a one skip is allowable since the medial lines of the skip-neighbors compensate for there being no depth-correspondence of the skipped edges by providing a medial region which contains the skipped edges. Since the medial lines which define this region are about the same depth of the edges they enclose (some shallower, some deeper), the region may behave for all intents and purposes as being created by medial lines of the same depth as the edges it encloses. However, if there exists a two skip, then this same type of simulated medial region which encloses the deepest edges of the skip region must be comprised of medial lines which are at least as deep as the deepest skip-neighbor. Thus this region will lack medial lines which are shallower than the edges it is enclosing. In this respect, it would seem similar to the regions set up in circular networks and may face the same problems in that it may not be able to be controlled as well as needed (e.g., be able to make sharp enough turns).

In fact, it might not be so coincidental that the shallowest edge that cannot be recovered in the level four hexagonal network is the level 2-2 edge (see **Figure 13**). As shown in **Table 1**, the level 2-2 edge is the second edge in the two skip-- the edge whose surrounding medial region is defined entirely by medial lines deeper than itself. Not all networks which are not *Landrum*-recoverable experience this phenomena, but it may be important.

Although there has not been much research put into the idea, if it were possible to show the exact relation the medial lines and the types of medial regions they can define, then perhaps this argument could be proven rigorously. It seems that there is a correspondence between the depths of the intersecting medial lines which define medial regions, but finding and proving this would require much more time, but would most likely yield much information.

References

- [1] E. B. CURTIS, D. INGERMAN, AND J. A. MORROW, *Circular Planar Graphs and Resistor Networks*, (1994), p. 7.